

VHF UHF Helical Filter Specification Sheet

Customer Name		Temwell's Part No.	TTW3757B-2550M
Approval No. /dated	201407159CD	Temwell's Print Name.	3757B 2550M
Work Instruction No.	201407159CD	Date	Jan.20.2015

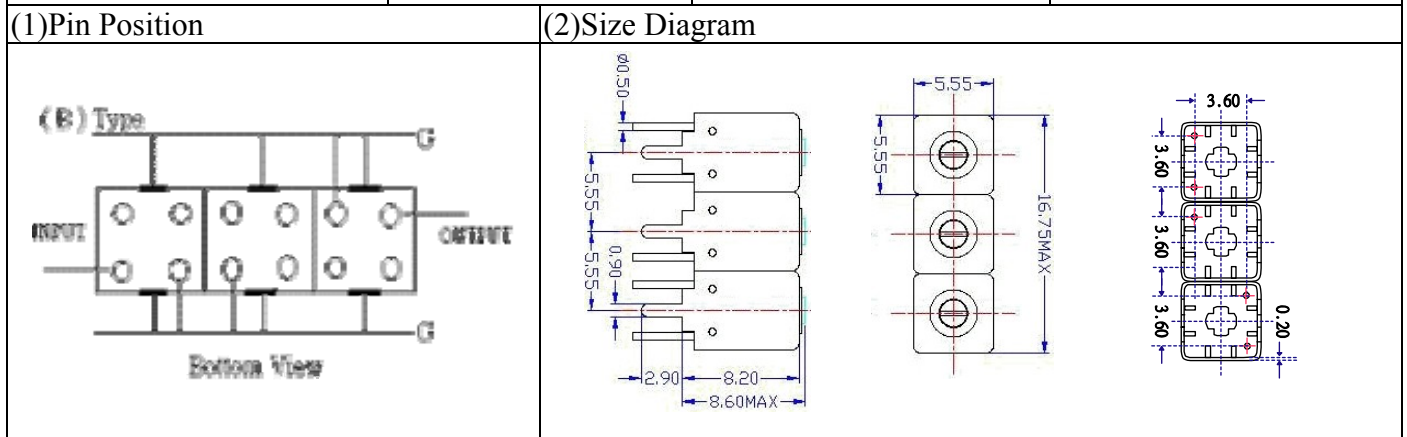

(3) Electric Character			
Item		Specify	Performance
Center Freq.(Fo) +/- 0.5 %		2550 MHz	2550 MHz
Insertion Loss		Typ. 4.0 dB	2.84 dB
-3 dB Bandwidth		Typ. 50 MHz	74.4 MHz
Sensitivity (Attenuation)	Fo - 150 MHz	Typ. 28 dBc	31 dBc
	Fo + 150 MHz	Typ. 20 dBc	24 dBc
	Fo - ()MHz	Typ. dBc	dBc
	Fo +()MHz	Typ. dBc	dBc
Return Loss		Min. 12 dB	22.5 dB
Ripple		< 1 dB	dB
Impedance		In / Out : 50 Ω	In / Out : 50 Ω
(4) Torque for Tuning Screw		> 60gf • cm	
(5) Temperature Condition:			
Operating Temperature		0°C ~ +60°C	
Storage Temperature		-20°C ~ +70°C	
(6) Input Power		> 0.5Watt	

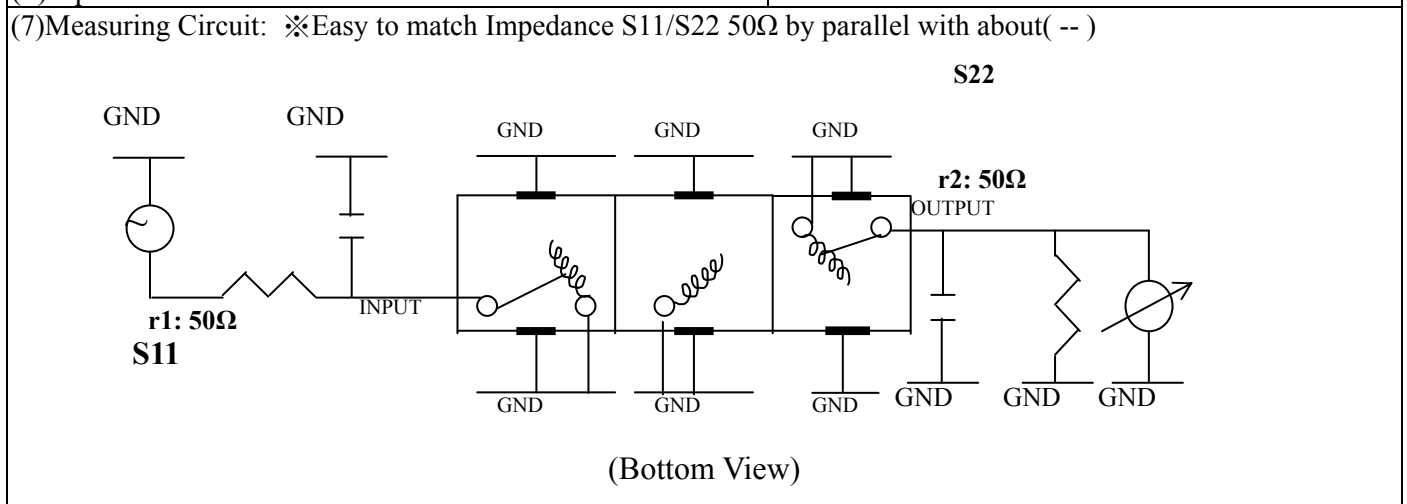

Approval	Supervisor	Designer	Aperture size
C.Y.Chang	C.K.Chang	C.S.Chang	5W3S(3.8*3.5)(3.56) 5HW046RB3.2(J1)

TEMWELL CORPORATION

Performance-TTW3757B-2550M

201407159CD

Tr1 S11 Log Mag 5.000dB/ Ref 0.000dB [F2]
Tr2 S21 Log Mag 10.00dB/ Ref 0.000dB [F2]

