

VHF UHF Helical Filter Specification Sheet

Customer Name		Temwell's Part No.	TTW3723B-2275M
Approval No. /dated	201407146CD	Temwell's Print Name.	3723B 2275M
Work Instruction No.	201407146CD	Date	Dec.25.2014

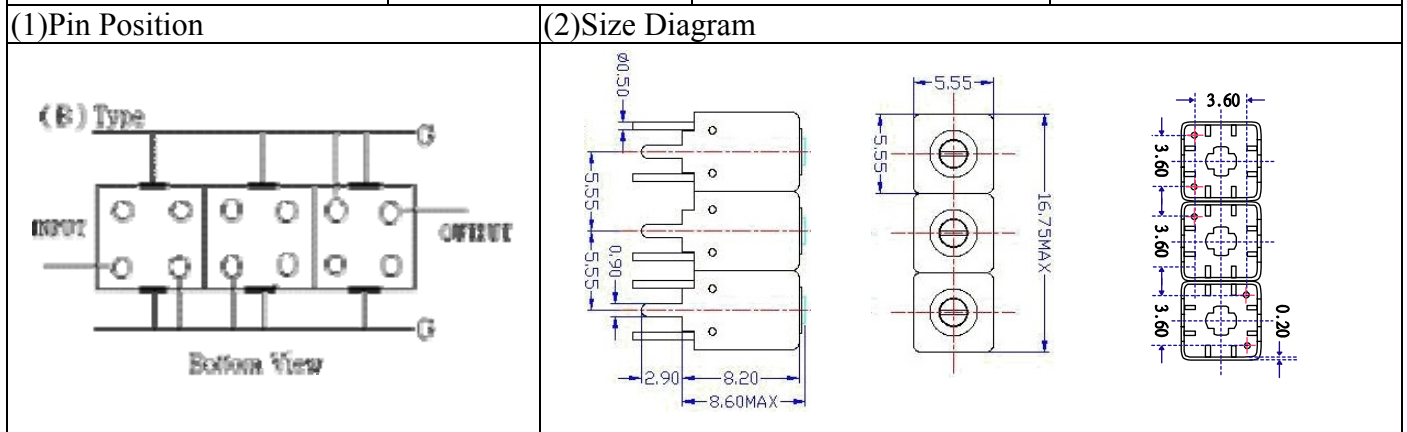

(3) Electric Character					
Item		Specify		Performance	
Center Freq.(Fo) +/- 0.5 %		2275 MHz		2275 MHz	
Insertion Loss		Typ. 4.5 dB		3.85 dB	
-3 dB Bandwidth		Typ. 34 MHz		46.6 MHz	
Sensitivity (Attenuation)	Fo - 100 MHz	Typ. 26 dBc		29 dBc	
	Fo + 100 MHz	Typ. 21 dBc		23 dBc	
	Fo - ()MHz	Typ. dBc		dBc	
	Fo +()MHz	Typ. dBc		dBc	
Return Loss		Min. 12 dB		17.6 dB	
Ripple		< 1 dB		dB	
Impedance		In / Out : 50 Ω		In / Out : 50 Ω	
(4) Torque for Tuning Screw		> 60gf · cm			

(5) Temperature Condition:	
Operating Temperature	0°C ~ +60°C
Storage Temperature	-20°C ~ +70°C
(6) Input Power	> 0.5Watt

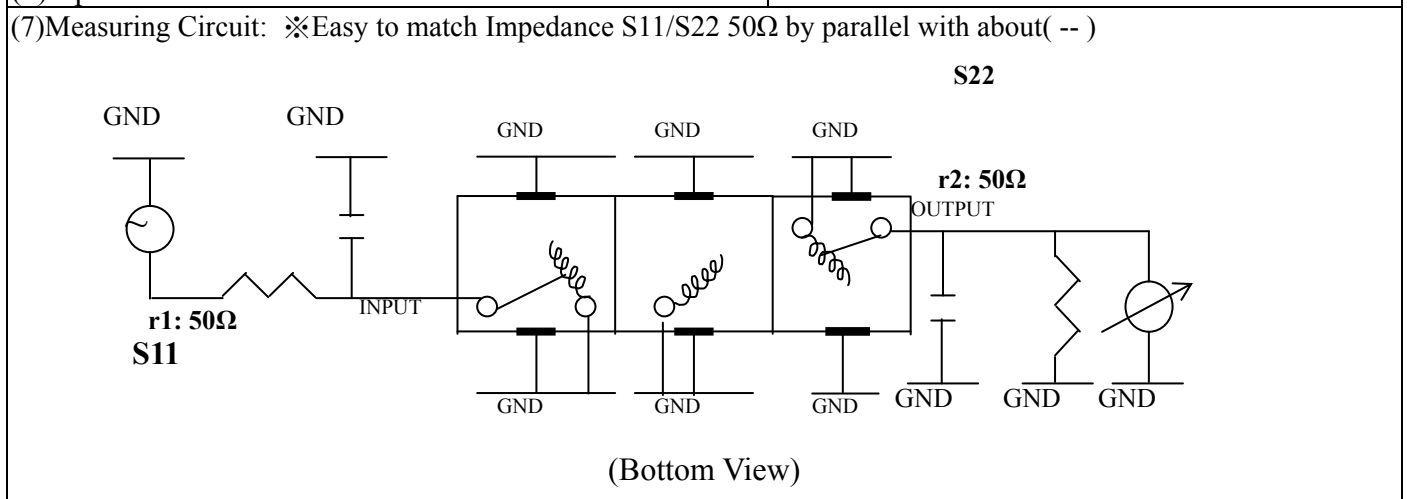

Approval	Supervisor	Designer	Aperture size
C.Y.Chang	C.K.Chang	C.S.Chang	5W3S(3.8*3.5)(3.56) 5HW046RB3.2(J1)

TEMWELL CORPORATION

Performance-TTW3723B-2275M

201407146CD

