

VHF UHF Helical Filter Specification Sheet

Customer Name		Temwell's Part No.	TTW3523B-2075M
Approval No. /dated	201407070CD	Temwell's Print Name.	3523B 2075M
Work Instruction No.	201407070CD	Date	Oct.23.2014

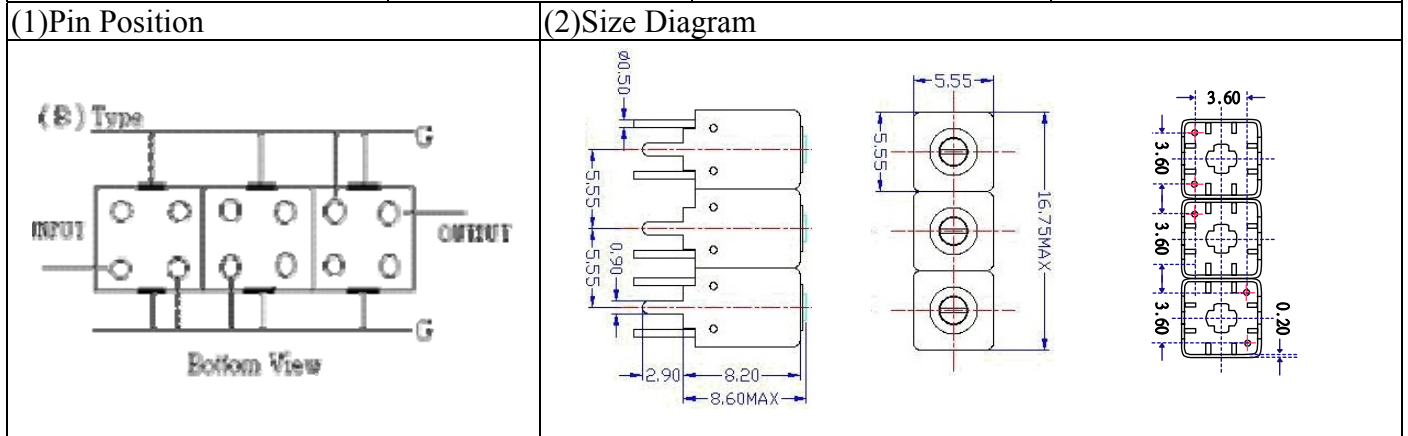

(3) Electric Character			
Item		Specify	Performance
Center Freq.(Fo) +/- 0.5 %		2075 MHz	2075 MHz
Insertion Loss		Typ. 3.5 dB	2.85 dB
-3 dB Bandwidth		Typ. 47 MHz	67.1 MHz
Sensitivity (Attenuation)	Fo - 150 MHz	Typ. 35 dBc	40 dBc
	Fo + 150 MHz	Typ. 24 dBc	29 dBc
	Fo - ()MHz	Typ. dBc	dBc
	Fo +()MHz	Typ. dBc	dBc
Return Loss		Min. 12 dB	34.2 dB
Ripple		< 1 dB	dB
Impedance		In / Out : 50 Ω	In / Out : 50 Ω
(4) Torque for Tuning Screw			
		> 60gf · cm	
(5) Temperature Condition:			
Operating Temperature		0°C ~ +60°C	
Storage Temperature		-20°C ~ +70°C	
(6) Input Power			
		> 0.5Watt	

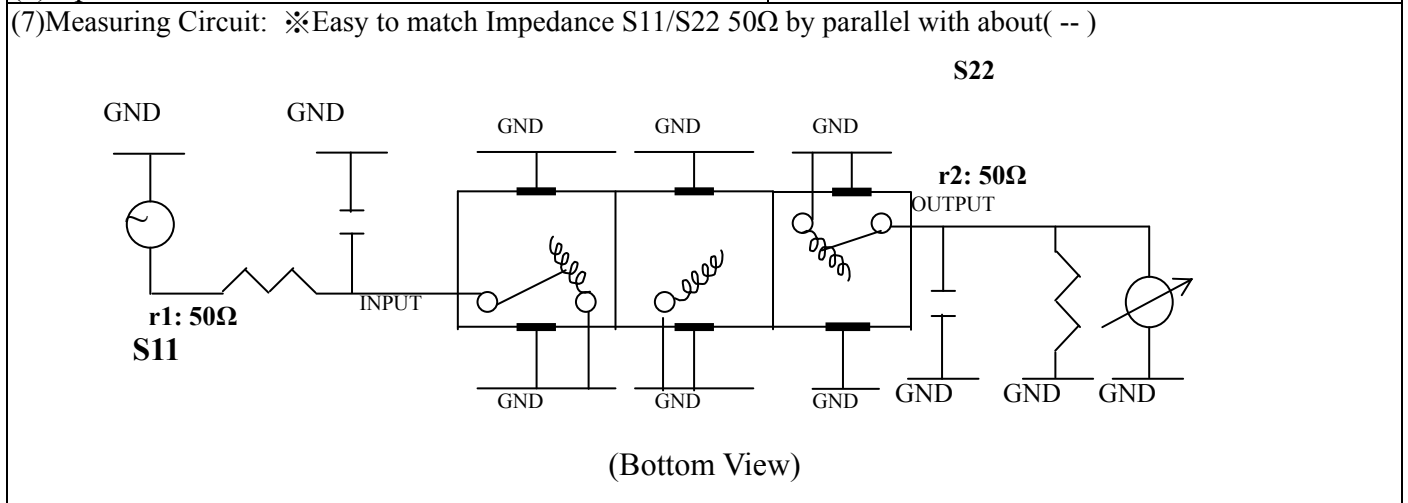

Approval	Supervisor	Designer	Aperture size
C.Y.Chang	C.K.Chang	C.S.Chang	5W3S(3.8*4.0)(4.05) 5HW046RB3.2(J1)

TEMWELL CORPORATION

Performance-TTW3523B-2075M

201407070CD

